

# 2010 Replacement Parts Price List

**Residential and Commercial Water Heater  
Repair Parts and Installation Accessories**

**Now!**

**24/7 Online Parts Search...**

**Look-up Tab at**

**[www.statewaterheaters.com/parts](http://www.statewaterheaters.com/parts)**

**Prices Effective October 1, 2010**



**[www.statewaterheaters.com](http://www.statewaterheaters.com)**

**Replacement Parts**

## Ordering Information

<b>Ordering</b>	Please have complete part number(s) and description(s) available when ordering. We also suggest you have the model, series and serial number of the model available when calling. NOTE: Minimum parts order amount is \$50.00 list (\$25.00 net). Refer to owner's manual for a list of all available repair parts.			
<b>Contact Us</b>	Telephone <b>800-821-2017</b> , FAX <b>800-644-9306</b>			
<b>Order Processing Time</b>	Regular-2 work days Accelerated (by request at added cost)-next working day. Acceptable orders are considered received the following business day when received after 4:00 pm Central Time	<b>Shipping Method Chart</b>		
		<b>CARRIER</b>	<b>REGULAR</b>	<b>ACCELERATED</b>
<b>Departure Schedule (Monday-Friday)</b>	4:00 p.m. Central Time	<b>UNITED PARCEL SERVICE</b>		
		1. UPS - Ground	X	
		2. UPS 2nd day air - limited to U.S.		X
		3. UPS - Next day air - area limited		X
		<b>AIR EXPRESS</b>		
			X	

<b>Packaging</b>	Parts are available in a variety of packaging options, including Bagged and Boxed. Bagged where available is the standard and will be shipped unless otherwise specified. Packing codes will be listed on the end of each part number; (example: 9000071015) packaging codes are as follows: Bagged 015, 115 and 215, Boxed 005, 105 and 205. All parts prices shown are for parts ordered in carton quantities. The number of parts per carton is shown. Add 25% to prices shown when ordering less than carton quantities. Please order by Part Number and Description. Specify packaging if other than standard.
<b>Acceptance of Order</b>	The price sheet does not constitute an offer to sell. All orders are subject to final approval and acceptance. Prices, terms and specifications are subject to change without notice. Billing prices are those in effect on the date of shipment.
<b>Terms</b>	2% 10th Prox., Net 25th
<b>Freight Allowance</b>	LTL freight shipments will be made collect, unless otherwise specified. UPS and Parcel Post shipments will be prepaid and the cost included in the invoice. Freight will be allowed and prepaid on single destination parts orders over \$1,500.00, suggested list (\$750.00 Net), (excluding UN LIME) within the continental United States. Air freight charges are not included. For UN LIME Delimer, 200 gallons or more of UN LIME will be shipped freight prepaid as outlined above. 100 gallons or more (up to 199 gallons) of UN LIME, in conjunction with list price orders of \$1,500.00 or more will be shipped freight prepaid as outlined above.
<b>Cancellation Policy</b>	Cancellations made after product has shipped, will be subject to a 25% restocking charge plus any freight and damages incurred.
<b>Return of Merchandise</b>	No material may be returned for adjustment of any nature whatsoever without an authorized return number. A 25% restocking charge will be applied. Return of an State Industries replacement part requires approval. All returned parts should be returned in SALEABLE condition and all kits should be returned in their ENTIRETY with components. Acceptance is subject to our inspection and a 25% restocking charge. ASMMI00105 tags may not be used to return SALEABLE parts.
<b>Error Claims</b>	Claims for errors in shipment, invoicing and/or credits must be made to State Industries, 500 Tennessee Waltz Parkway, Ashland City, TN 37015. For all shipments, invoicing and/or credit errors claims not made with 30 days of delivery of shipment, date of invoice and/or date of credit, shall be deemed waived.

**PRICES IN EFFECT AT TIME OF SHIPMENT WILL GOVERN, AND ARE SUBJECT TO CHANGE WITHOUT NOTIFICATION.**

### Limited Warranty

State Industries replacement parts carry a limited warranty against defects in material and workmanship. State Industries replacement parts found to be defective within the expressed warranty period will be replaced, provided they are returned prepaid within 30 days of the date of failure and our inspection validates the claim. A completed form ASMMI00105 Parts Return Tag must be submitted with the defective part. Tags are available from State Industries, 500 Tennessee Waltz Parkway • Ashland City, TN 37015 or phone your request to 800-821-2017 or fax to 800-644-9306.

Under the new UPS Web-Based Return Program, State Industries will pay the return freight on defective parts replaced under warranty. **Please note that the UPS Web-Based Return Program is NOT to be used for coils, heat exchangers or new (unused) parts being returned for credit.**

No other warranty, either expressed or implied (including but not limited to a warranty of merchantability) is made on behalf of State Industries with respect to replacement parts.

# Table of

# CONTENTS

# Table of CONTENTS

<b>Residential</b>	<b>PAGE</b>
CONTACT/ORDERING INFORMATION .....	Inside Front Cover
PREMIUM SCREW-IN ELEMENTS .....	2
MID-LINE SCREW-IN ELEMENTS .....	3
BASIC SCREW-IN ELEMENTS .....	4
SPECIALTY ELEMENTS .....	5, 6
TEMPERATURE CONTROLS .....	7, 8, 9, 10
PILOT ASSEMBLY & GAS THERMOSTATS .....	11
THERMOCOUPLES & MISCELLANEOUS .....	12
BLOWER ASSEMBLIES & SWITCHES .....	13
COMMON POWER VENT REPAIR PARTS .....	14
HOT SURFACE IGNITION REPAIR PARTS .....	15
COMMON REPLACEMENT PARTS .....	16
PRESSURE RELIEF VALVES .....	17
INSTALLATION ACCESSORIES .....	18, 19
WARRANTY EXTENSION KITS .....	Inside Back Cover

<b>Commercial</b>	<b>PAGE</b>
FLANGED ELEMENTS & THERMOSTATS .....	20
IGNITERS & TEMPERATURE CONTROLS .....	21
CONTACTORS/TRANSFORMERS/HIGH LIMIT CONTROLS .....	22
GAS VALVES .....	23
PILOT BURNERS & I.I.D. CONTROLS .....	24
FLUE DAMPERS, COILS & HEAT EXCHANGERS .....	25
PUMPS .....	26
SYSTEM PACKAGES .....	27
VF & GW VENTING .....	28
ACCESSORIES & TOOLS .....	29, 30
DELIMING ACCESSORIES & TOOLS .....	31
FLUE DAMPERS/DRAFT HOODS .....	17
HIGH EFFICIENCY .....	32, 33, 34, 35, 36



# RESIDENTIAL

## Premium Screw-in Elements

### FEATURES & BENEFITS OF LOW-WATT DENSITY ELEMENTS

- For residential and light commercial use
- Nickel-alloy sheathing
- Long lasting, lowest practical watt density
- Includes gasket
- Screw-in element

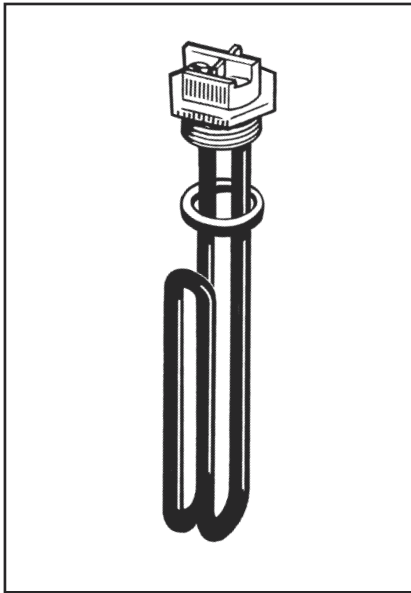

### INCOLOY NICKEL BASE ELEMENTS

Part Number	Volts	Watts	"A" Dim. (Inches)	List Price
9004279115	120	1500	9	\$27.40
9004284115	208	2000	9	35.40
9004753115	208	5000	16.5	49.40
9004289115	208	6000	16.5	47.20
9004290115	240	1500	9	30.40
9004283115	240	2000	11.5	28.80
9004291115	240	2500	11	45.80
9000664015	240	3000	13.5	47.00
9004292115	240	3500	13.75	36.60
9000225015	240	3800	14	34.40
9004751115	240	4000	16	45.80
9003210115	240	4500	13.75	33.60
9000405015*	240	4500	14	42.80
9004293115	240	5000	16	42.60
9004294115	240	5500	13.5	37.80
9000396015*	240	5500	14	46.00
9004749115	240	6000	16.5	46.60
9004296115	277	3000	16.5	48.40
9004297115	277	4500	16.5	53.80
9004298115	480	2000	16	32.60
9004300115	480	3000	16.5	48.00
9004763115	480	4000	16.5	53.20
9004760115	480	4500	16.5	53.80
9004761115	480	5000	16.5	53.00
9004762115	480	6000	16.5	51.20

\*Super Premium

### SCREW-IN ELEMENT for 2 and 4 gallon models

Part Number	Volts	Watts	"A" Dim. (Inches)	List Price
9005406105	120	1500	8	\$100.20

Notes:

---



---



---



---



---

# Mid-Line Screw-in Elements

## CORROGARD ZINC-PLATED COPPER ELEMENTS

### FEATURES & BENEFITS OF CORROGARD ZINC-PLATED COPPER ELEMENTS

- Improved durability
- Lowest practical watt density for size
- For residential and light commercial use
- Zinc-plated for corrosion protection
- Includes gasket
- Screw-in element

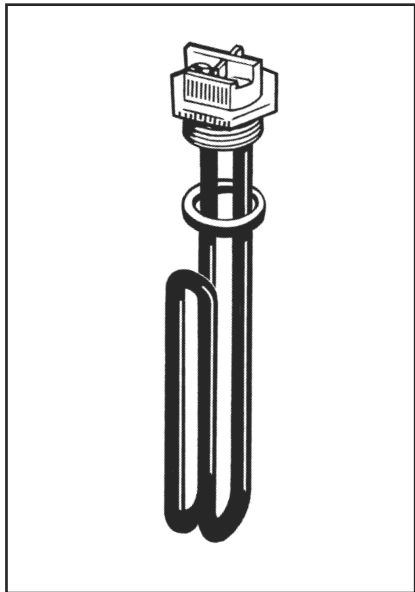

Notes:

---



---



---



---



---



---



---

Part Number	Volts	Watts	"A" Dim. (Inches)	List Price
9004777105	120	1500	11.00	\$13.60
9003947115	120	2000	11.50	15.20
9002859115	120	2500	11.50	24.20
9002862115	120	3000	11.75	19.60
9004705115	208	1500	13.50	20.40
9002858115	208	2000	13.50	29.40
9002961115	208	2500	13.50	22.80
9004706115	208	3000	13.50	24.00
9004489105	208	4000	13.50	26.60
9002645115	208	4500	13.50	22.80
9001224115	208	5000	16.00	40.00
9003953115	208	6000	16.00	28.40
9000143115	240	1000	8.00	14.00
9002864115	240	1500	11.00	25.80
9000145115	240	2000	13.50	15.60
9002860115	240	2500	12.50	16.20
9003959115	240	3000	11.75	16.40
9004712115	240	3500	13.50	17.60
9000148015	240	3800	12.00	16.60
9002868115	240	4000	13.50	18.20
9000095015	240	4500	14.00	17.00
9000150115	240	5000	16.00	19.00
9002867115	240	5500	16.00	20.40
9003952115	240	6000	16.00	23.00
9004708115	277	1500	11.50	22.00
9004709115	277	2000	13.50	23.60
9002890115	277	2500	13.50	31.80
9003958115	277	3000	11.75	27.00
9003960115	277	4500	13.50	29.40
9002874115	277	6000	15.50	38.40
9002861115	480	2500	11.50	39.80
9003961115	480	3000	13.75	28.00
9002869115	480	4000	13.50	39.60
9004710115	480	4500	16.00	25.80
9004711115	480	5000	16.00	33.00
9002875115	480	6000	13.50	47.20

RESIDENTIAL  
Mid-Line Screw-in Elements

## Basic Screw-in Elements

# Basic Screw-in Elements

### FEATURES & BENEFITS OF HIGH-WATT DENSITY ELEMENTS

- For residential and light commercial use
- Zinc-plated for corrosion protection
- Includes gasket
- Screw-in element

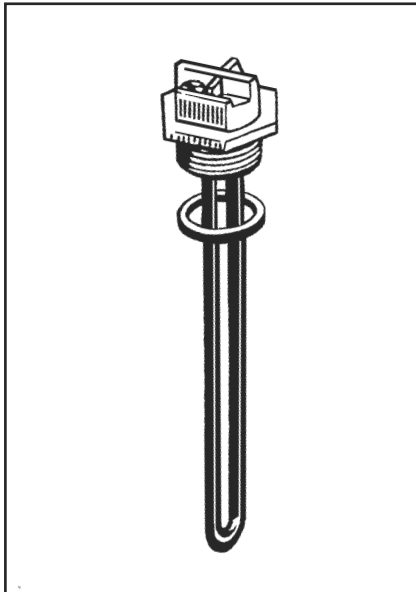

### HIGH-WATT DENSITY ELEMENTS

Part Number	Volts	Watts	"A" Dim. (Inches)	List Price
9004738115	120	750	8.00	\$13.20
9004739115	120	1000	8.00	12.80
9004740115	120	1500	8.00	12.40
9004741115	120	2000	10.00	12.40
9004742115	120	2500	10.00	13.00
9004746115	208	6000	12.00	25.80
9004745115	240	1500	8.00	12.80
9003946115	240	2000	8.00	12.80
9003954115	240	2500	10.00	13.00
9003955115	240	3000	10.00	12.60
9003948115	240	3500	12.00	12.80
9000136015	240	3800	12.00	12.20
9003956115	240	4000	12.00	13.40
9000092015	240	4500	12.00	13.40
9003957115	240	5000	10.00	16.60
9003951115	240	5500	12.00	16.00
9001225115	480	4500	12.00	27.80
9004748115	480	6000	12.00	33.40

Notes:

---



---



---



---



---



---



---

# Specialty Elements

RESIDENTIAL

RESIDENTIAL

Specialty Elements

## PREMIUM UNIVERSAL FLANGE ELEMENTS

Part Number	Volts	Watts	"A" Dim. (Inches)	List Price
9000970015	240	4500	14.00	\$41.20
9000971015	240	5500	14.00	41.00

## MID-LINE UNIVERSAL FLANGE ELEMENTS

Part Number	Volts	Watts	"A" Dim. (Inches)	List Price
9000965015	120	1500	8.00	\$17.00
9000097015	240	4500	14.00	17.40

## BASIC UNIVERSAL FLANGE ELEMENTS

Part Number	Volts	Watts	"A" Dim. (Inches)	List Price
9002072005	120	1650	8.00	\$12.20
9000177015	120	1500	8.00	12.60
9000178015	120	2000	8.00	13.20
9000180015	240	1500	8.00	13.00
9000182015	240	2500	10.00	13.20
9000183015	240	3000	12.00	13.60
9000184015	240	3800	12.00	14.60
9000094015	240	4500	14.00	12.80

## PREMIUM 1 3/8" SCREW-IN FLANGE ELEMENTS

Part Number	Volts	Watts	"A" Dim. (Inches)	List Price
9002451015	240	3000	14.00	\$38.60
9002434015	240	3800	14.00	40.00
9002450015	240	4500	14.00	44.00
9002433015	240	5500	14.00	45.20

# Specialty Elements

## MID-LINE 1 3/8" SCREW IN FLANGE ELEMENTS

Part Number	Volts	Watts	"A" Dim. (Inches)	List Price
9002441015	240	3000	14.00	\$19.60
9002449015	240	3800	14.00	20.40
9002442015	240	4500	14.00	22.40
9002448015	240	5500	14.00	26.00

## DRY WELL ELEMENT

Part Number	Volts	Watts	List Price
9000100005	120	1500	\$30.00

## SOLAR ELEMENT

Part Number	Volts	Watts	List Price
9000050005	240	4500	\$42.40

Notes:

---

---

---

---

---

---

---

---

---

---



# Temperature Controls

RESIDENTIAL

RESIDENTIAL  
Temperature Controls

## ELECTRIC THERMOSTATS

Part Number	Model	Description	List Price
9001954015*	WH10-A	UPPER THERMOSTAT WITH E.C.O.-240 V.A.C . -ADJUSTABLE	\$26.20
9000507015*	WH9	LOWER THERMOSTAT- 240 V.A.C.	12.00
9000509015*	WH9-6	SINGLE ELEMENT HEATER THERMOSTAT W/E.C.O. 12/240 V.A.C.	22.80
9002394015		(POINT OF USE 2 AND 4 GALLON WATER HEATER THERMOSTAT)	29.40
W/E.C.O. 120 W.A.C. AND 240 V.A.C. BAGGED ONLY (THRU SEPT. 1996)			
9000650015*	WH9C	LOWER DAIRY BARN THERMOSTAT	17.60
9002856015*	WH10C-6	UPPER DAIRY BARN THERMOSTAT	44.00
9002857015*	WH9C-6	180 DEGREE LOWER THERMOSTAT	39.60
* WARNING — DO NOT USE ON POINT-of-USE MODEL HEATERS			

## MISCELLANEOUS ELECTRIC PARTS

Part Number	Description	List Price
9000030015	ELEMENT ADAPTER KIT	\$13.60
9000443015	ELEMENT GASKET ASSORTMENT	9.40
9000429015	HEAVY DUTY ELEMENT WRENCH (Socket Length 5")	12.40
9004704115	SQUARE FLANGE - 2 1/2" Bolt Circle - 1 49/64" Centers	11.00
9005897015	PLUG FOR 1- 1/4" SCREW-IN ELEMENT OPENING	4.00

Notes:

---



---



---



---



---



---

# RESIDENTIAL

## Temperature Controls

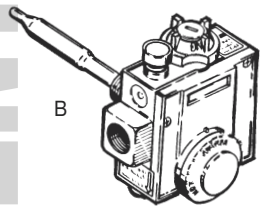

### ROBERTSHAW® CONTROLS

Part Number	Description	List Price
B 9005400105	Temperature control for Natural gas, 3 1/2" manifold pressure setting, pilot pressure fixed w/ECO cut off at 195 F; Temperature range to 160 F. (A=1 1/4")	\$140.40
B 9005401105	Temperature control for Natural gas, 3 1/2" manifold pressure setting, pilot pressure fixed w/ECO cut off at 195 F; Temperature range to 160F. (A=2")	176.80

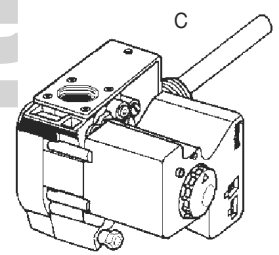

### HONEYWELL® SMARTVALVE CONTROLS

Part Number	Description	List Price
C 9004440105	Gas control for NATURAL gas, 3 1/2" manifold pressure setting. Maximum temperature range 160°F. (A=1.4")	\$386.00
C 9004441105	Gas control for PROPANE gas, 10" manifold pressure setting. Maximum temperature range 160°F. (A=1.4")	388.00
C 9004442105	Gas control for NATURAL gas, 3 1/2" manifold pressure setting. Maximum temperature range 160°F. (A=2.5")	381.00
C 9004443105	Gas control for PROPANE gas, 10" manifold pressure setting. Maximum temperature range 160 °F. (A=2.5")	387.00
C 9004444105	Gas control for NATURAL gas, 3 1/2" manifold pressure setting. Maximum temperature range 180 °F. (A=2.06")	390.00
C 9004445105	Gas control for PROPANE gas, 10" manifold pressure setting. Maximum temperature range 180°F. (A=2.06")	434.80
C 9004446105	Gas control for NATURAL gas, 3 1/2" manifold pressure setting. Maximum temperature range 160°F. (A=2.06")	398.20
C 9004447105	Gas control for PROPANE gas, 10" manifold pressure setting. Maximum temperature range 160°F. (A=2.06")	423.20

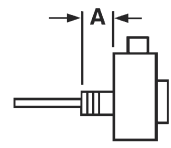

Notes:

---



---



---



---



---



---



---

# Temperature Controls

RESIDENTIAL

RESIDENTIAL

Temperature Controls

## WHITE RODGERS® INTELLIVENT CONTROLS

Part Number	Description	List Price
9004240005	Gas control for NATURAL gas, 3 1/2" manifold pressure setting. Maximum temperature range 160°F. (A=1.72")	\$377.80
9004310005	Gas control for PROPANE gas, 10" manifold pressure setting. Maximum temperature range 160°F. (A=1.72")	387.80
9004267005	Gas control for NATURAL gas, 3 1/2" manifold pressure setting. Maximum temperature range 160°F. (A=2.82")	388.00
9004464005	Gas control for PROPANE gas, 10" manifold pressure setting. Maximum temperature range 160°F. (A=2.82")	390.80
9004465005	Gas control for NATURAL gas, 3 1/2" manifold pressure setting. Maximum temperature range 160°F. (A=2.38")	383.80
9003691005	Gas control for NATURAL gas, 4" manifold pressure setting. Maximum temperature range 160°F. (A=1.72")	361.40
9003629005	Gas control for NATURAL gas, 4" manifold pressure setting. Maximum temperature range 160°F. (A=2.38")	409.00
9005108005	Thermostat Gas W/R NATURAL 1.45" SHANK	353.60
9005109005	Thermostat Gas W/R PROPANE 1.45" SHANK	363.60
9005112005	Thermostat Gas W/R PROPANE 1.25" SHANK	353.80
9005113005	Thermostat Gas W/R NATURAL 2.25" SHANK	355.20
9005114005	Thermostat Gas W/R PROPANE 2.25" SHANK	363.80
9004312005	Thermostat Gas W/R NATURAL 1.25" SHANK	312.40
9005962005	Thermostat Gas W/R NATURAL 1.25" SHANK	372.40
9005963005	Thermostat Gas W/R PROPANE 1.25" SHANK	363.60
9005964005	Thermostat Gas W/R NATURAL 2.25" SHANK	388.80
9005965005	Thermostat Gas W/R PROPANE 2.25" SHANK	384.00
9005110005	Thermostat Gas W/R NATURAL 1.45" SHANK	378.80
9005111005	Thermostat Gas W/R PROPANE 1.45" SHANK	378.20

### FEATURES & BENEFITS

- Safe lighting features permits lighting without danger of main gas flow
- 100% gas shutoff if pilot fails

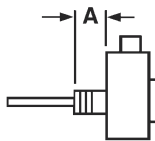

Notes:

---



---



---



---



---

# RESIDENTIAL Temperature Controls

## WHITE RODGERS® CONTROLS FVIR Related

Part Number	Description	List Price
D 9004703105	Temperature control for NATURAL gas, 3 1/2" manifold pressure setting, pilot pressure fixed w/ECO cut off at 195°F; Temperature range to 160°F. (A = 1 1/4")	\$108.00
D 9004353105	Temperature control for NATURAL gas, 3 1/2" manifold pressure setting, pilot pressure fixed w/ECO cut off at 195°F; Temperature range to 160°F. (A = 2 1/2")	121.40
D 9004028205	Temperature control for NATURAL gas, 4" manifold pressure setting, pilot pressure fixed w/ECO cut off at 195°F; Temperature range to 160°F. (A = 1 1/4")	150.00
D 9003739005	Temperature control for NATURAL gas, 4" manifold pressure setting, pilot pressure fixed w/ECO cut off at 195°F; Temperature range to 160°F. (A = 2 1/2")	154.20
9003407005	Temperature Control for NATURAL gas, 4" manifold pressure setting, pilot pressure fixed w/ECO cut off at 195°F; Temperature range to 160°F. (A=1 1/4")	121.80
9003638005	Temperature Control for NATURAL gas, 4" manifold pressure setting, pilot pressure fixed w/ECO cut off at 195°F; Temperature range to 160°F. (A = 2 1/2")	128.60
E 9004713105	Temp. control for PROPANE gas, 10" manifold pressure. setting, pilot pressure fixed w/ECO cut off at 195°F; Temp. range to 160°F. RIGHT HAND THREAD BURNER TUBE CONNECTION. (A = 1 1/4")	255.60
E 180192-003	Temp. control for PROPANE gas, 10" manifold pressure setting, pilot pressure fixed w/ECO cut off at 195°F; Temp. range to 160°F. RIGHT HAND THREAD BURNER TUBE CONNECTION. (A = 2 1/2")	278.20
E 9003408005	Temp. control for PROPANE gas, 10" manifold pressure setting, pilot pressure fixed w/ECO cut off at 195°F; Temp. range to 160°F. LEFT HAND THREAD BURNER TUBE CONNECTION. (A = 1 1/4")	288.80
9003639005	Temp. control for PROPANE gas, 10" manifold pressure setting, pilot pressure fixed w/ECO cut off at 195°F; Temp. range to 160°F. LEFT HAND THREAD BURNER TUBE CONNECTION. (A = 2 1/2")	306.40
E 9003656005	Temperature control for PROPANE gas 10 manifold pressue setting, pilot pressue fixed w/ECO cut off at 195 F; Temperature range to 160 F	401.20

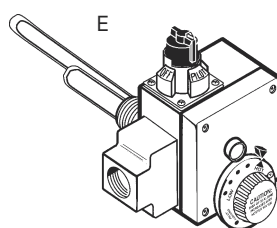
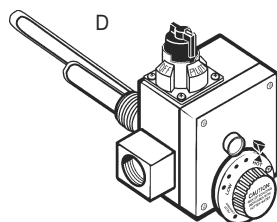
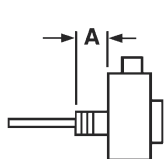

# Pilot Assembly & Gas Thermostats

RESIDENTIAL  
Pilot Assembly & Gas Thermostats

## PILOT ASSEMBLY

Part Number	Description	List Price
9003541005	FV PILOT ASS'Y 160° - PROPANE	\$49.20
9003488005	FV PILOT ASS'Y 170° - HIGH ALTITUDE	49.20
9003472005	FV PILOT ASS'Y 170° - PROPANE	49.20
9003531005	FV PILOT ASS'Y 180° - HIGH ALTITUDE	49.20
9003455005	FV PILOT ASS'Y 180° - PROPANE	49.20
9003542005	FV PILOT ASS'Y 190° - HIGH ALTITUDE	49.20
9003543005	FV PILOT ASS'Y 190° - PROPANE	49.20
9003521005	FV PILOT ASS'Y 200° - NATURAL	49.20
9003544005	FV PILOT ASS'Y 200° - PROPANE	49.20

## GAS THERMOSTATS; BOXED

Part Number	Description	List Price
9000246005	NATURAL GAS-THROUGH 55,000 BTU'S	\$155.40
9000247005	PROPANE GAS Short Shank - Right Hand Threads	273.40
9000248005	NATURAL GAS-OVER 55,000 BTU'S	153.40
9000249005	NATURAL GAS -LONG SHANK-2 5/8" SHANK	167.60
9002454005	NATURAL GAS-LONG SHANK Over 55,000 BTU'S	208.60
9000250005	PROPANE GAS-LONG SHANK-2 5/8" SHANK- RIGHT HAND THREADS	284.00
9000251005	CONVERTIBLE CONTROL-SHORT SHANK (MOBILE HOME MODELS ONLY)	285.60
9000796005	CONVERTIBLE CONTROL-LONG SHANK (MOBILE HOME MODELS ONLY)	302.40
9002997005	CONVERTIBLE CONTROL-MOBILE HOME	284.20
9002122005*	PROPANE GAS-SHORT SHANK-LEFT HAND THREADS	272.40
9002123005*	PROPANE GAS-LONG SHANK-LEFT HAND THREADS	286.20
	*MODELS MANUFACTURED 6-1-93 OR AFTER.	

Notes:

---



---



---



# RESIDENTIAL

## Thermocouples & Miscellaneous

Thermocouples & Miscellaneous

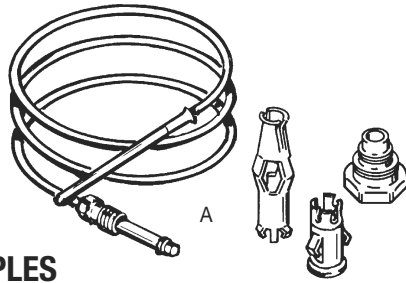

### THERMOCOUPLES

Part Number	Model	Description	List Price
A 9000876015	TC-K18	UP TO 18" THERMOCOUPLE KIT	\$10.60
A 9000056015	TC-K24	19-24" THERMOCOUPLE KIT	11.20
A 9000497015	TC-K36	31-36" THERMOCOUPLE KIT	16.00

### MISCELLANEOUS

Part Number	Description	List Price
B 9004473115	PILOT TUBE KIT 24" of 1/4" aluminum tubing with 2 compression fittings. (Use when tubing has been damaged or is too short after control replacement).	\$ 5.00
B 9004722115	PILOT TUBE KIT 16" of 1/8" aluminum tubing with 2 compression fittings.	6.80
B 9004723115	PILOT TUBE KIT 20" of 1/8" aluminum tubing with compression fittings.	7.20
C 9004966115	PIEZO IGNITER, spark igniter for Models FGCG/PGCG.	18.40
D 9004372115	NATURAL GAS PILOT ASSEMBLY	32.40
E 9004374115	ENERGY CUT-OFF	12.80
9003406005	AIR INTAKE SCREEN	3.40
9003410015	PIEZO IGNITOR W/ BRACKET	5.40
9003401005	INNER DOOR GASKET	12.20
9006478005	VACUUM NOZZLE	48.20
9006477005	WRAP AROUND FILTER	15.20

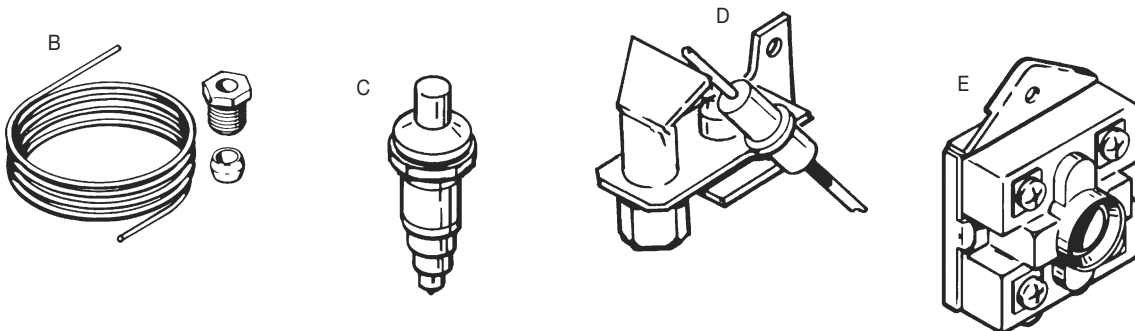

# Blower Assemblies & Switches

RESIDENTIAL  
Blower Assemblies & Switches

## BLOWER ASSEMBLIES

Part Number	Description	List Price
F 9004363105	Series 226/227	\$506.40
F 9004419105	Series 230-235	521.60
F 9004425105	Series 230/231/234/235	472.00
F 9004305005	Series 250/251	718.60
F 9004434105	Series 234/235	543.40
F 9004453105	Series 236/237	489.00
F 9004456105	Series 250/251	507.80
F 9004306005	Series 260/261	421.40
F 9004568105	Series 250/251, series 100/101	665.40
F 9004581105	Series 100, series 260	421.40

## BLOWER PRESSURE SWITCHES

Part Number	Description	List Price
G 9004654105	For Amtek/Jakel 21208 (FS-6070A-1833)	\$57.00
G 9004659105	For 182273 (FS-6085A-1903) - Inlet	54.40

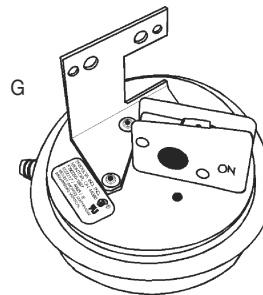
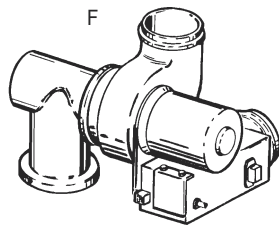

Notes:

---



---



---



---



---



---

# RESIDENTIAL Common Power Vent Repair Parts

Common Power Vent Repair Parts

## COMMON POWER VENT REPAIR PARTS

Part Number	Description	List Price
9002672005	BLOWER-40 & 50 Gal. THROUGH 52,500 BTU'S	\$213.00
9002507005	BLOWER-50 Gal. OVER 52,500 BTU'S	281.00
9001976005	AIR PRESSURE SWITCH-40 & 50 Gal.	50.20
9002511005	AIR PRESSURE SWITCH-75 Gal.	50.20
9002678005	RESET SWITCH	12.00
9004316005	BLOWER & MOTOR	364.40
9004027005	BLOWER ASSY	401.60

## 24 VOLT SYSTEM POWER VENT REPAIR PARTS (Older Style)

Part Number	Description	List Price
9001967005	GAS VALVE-24 VOLT	\$86.00
9001373005	TRANSFORMER-110 VOLT	21.40
9001974005	NATURAL GAS PRESSURE SWITCH	53.20
9002152005	PROPANE GAS PRESSURE SWITCH	53.20

## 120 VOLT SYSTEM POWER VENT REPAIR PARTS

Part Number	Description	List Price
9002355005	GAS VALVE-NATURAL-40 & 50 Gal.-Short Shank	\$253.60
9002356005	GAS VALVE-NATURAL-40 & 50 Gal.-Long Shank	268.40
9002453005	GAS VALVE-NATURAL-75 Gal.-Long Shank	268.40
9002353005	GAS VALVE-PROPANE-40 & 50 Gal.-Short Shank	487.80
9002354005	GAS VALVE-PROPANE-40 50 & 75 Gal.-Long Shank	503.60

## BLOWERS CURRENT DESIGN

Part Number	Description	List Price
9006030005	BLOWER ASSY	\$401.00
9006179005	BLOWER ASSY	313.00
9006458005	BLOWER ASSY	234.20

# Hot Surface Ignition Repair Parts

RESIDENTIAL

RESIDENTIAL  
Hot Surface Ignition Repair Parts

## GAS CONTROL POWER VENT REPAIR PARTS

Part Number	Description	List Price
9002751005	GAS VAVLE-NATURAL 1.75 SHANK-40 & 50 Gal.	\$577.80
9002752005	GAS VALVE-PROPANE 1.75 SHANK-40 & 50 Gal.	483.20
9002514005	GAS VALVE-NATURAL GAS-NATURAL-75 Gal.	520.80
9002515005	GAS VALVE-PROPANE GAS-PROPANE-75 Gal.	603.20

## HOT SURFACE IGNITION

Part Number	Description	List Price
9002518015	HOT SURFACE IGNITION	\$ 90.00
9003626005	HSI ASSY NAT 75	103.00
9005256015	REPLACEMENT IGNITER	120.60
9004448105	HOT SURFACE IGNITION	98.20
9004455105	HOT SURFACE IGNITION	184.80
9006931005	IGNITER/PILOT ASSY CURRENT DESIGN	99.40
9007098005	IGNITER/PILOT ASSY CURRENT DESIGN	54.60
9007107005	IGNITER	48.60
9007109005	IGNITER	57.20

## CURRENT GAS DESIGN (HSI Control Valves)

Part Number	Description	List Price
9006655005	Gas Control Valve/Thermostat (with lead wires - Natural)	\$129.80
9006656005	Gas Control Valve/Thermostat (with lead wires - Natural)	129.80
9006657005	Gas Control Valve/Thermostat (with lead wires - L.P.)	222.00
9006658005	Gas Control Valve/Thermostat (with lead wires - L.P.)	222.00
900666015	Pilot Assembly (Natural)	16.40
9006668015	Pilot Assembly (L.P.)	16.40
9006667015	Pilot Assembly (L.P.)	16.40
9006617005	Complete Burner/Door Assembly (Natural)	88.80
9006619005	Complete Burner/Door Assembly (Natural)	88.80
9006621005	Complete Burner/Door Assembly (Natural)	88.80
9006618005	Complete Burner/Door Assembly (L.P.)	109.20
9006620005	Complete Burner/Door Assembly (Natural)	88.80
9006622005	Complete Burner/Door Assembly (L.P.)	109.20

## Common Replacement Parts

Common Replacement Parts

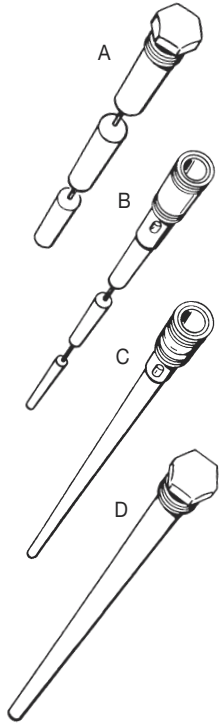

### ANODE RODS

Part Number	Description	Nipple	Length Overall (Inches)	List Price
A 9005742105	3/4" flexible plug anode rod	—	48.00	\$ 78.20
A 9005973005	3/4" flexible plug anode rod	—	48.00	103.40
B 9005975005	3/4" flexible outlet anode rod	—		35.80
C 9006212005	3/4" outlet anode rod	3	38.81	40.20
C 9006211005	3/4" outlet anode rod	3 1/4	44.38	47.40
D 9000029005	3/4" standard aluminum anode rod		29	23.80
D 9001829005	3/4" standard magnesium anode rod	—	32	40.60
D 9001453005	3/4" KA-90 anode rod. For smelly water	—	45	70.80

### DRAIN VALVES

Part Number	Description	"A" Dim. (Inches)	"B" Dim. (Inches)	List Price
9000254015	5/8" drain valve			\$ 6.80
9000058015	2" drain valve			6.80
9003098015	3" drain valve			21.80
9003906015	brass drain valve			10.80
9004635115	3/4" brass sediment flush valve	3	5	52.40
9004772115	3/4" brass drain valve	1 1/16	2 3/8	11.80
9003907015	3/4" brass drain valve	3	4 3/4	16.60
9001870015	3/4" brass drain valve	2	3 3/8	15.60
9002402015	3/4" brass drain valve	1 1/4	3 1/5	8.60
9000679015	3/4" plastic drain valve	1 3/4	3 3/4	8.60
9001588015	3/4" plastic drain valve	2 1/2	4 1/2	9.00

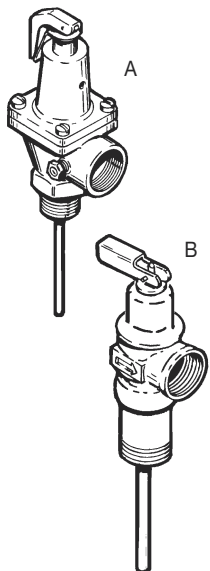

### TEMPERATURE AND PRESSURE RELIEF VALVES

Part Number	Description	ASME	A.G.A.	List Price
A 9005432105	1 1/2", 125#, T & P Relief Valve.	5,125,000	1,200,000	\$584.00
A 9003741005	3/4", 150#, T & P Relief Valve.	500,000	100,000	18.00
A 9005899205	3/4", 150#, T & P Relief Valve.	1,912,000	205,000	103.40
A 9007110005	1", 125#, T & P Relief Valve.	3,070,000	750,000	184.40
B 9006081005	1", 150#, T & P Relief Valve.	2,155,000	500,000	138.00
A 9006922005	3/4", 125#, T & P Relief Valve.	1,619,000	185,000	108.00
A 9006923005	3/4", 150#, T & P Relief Valve.	1,912,000	185,000	108.00
A 9006924005	1", 125#, T & P Relief Valve.	1,825,000	500,000	140.00
A 9005924205	1", 150#, T & P Relief Valve.	2,155,000	500,000	142.00
A 9006187205	1", 150#, T & P Relief Valve.	3,625,000	750,000	191.80
A 9006916005	1", 150#, T & P Relief Valve.	2,155,000	500,000	134.00



# Relief Valves

# RESIDENTIAL

# RESIDENTIAL Relief Valves

## RESIDENTIAL ORIENTATION TEMPERATURE & PRESSURE RELIEF VALVES ONLY

Part Number	Model	Description	List Price
C 9000071015	TP-100	5/8" Shank Fits most Gas & Electric Models (Except Direct Vent)	\$15.20
C 9000728015	TP-102	2" Shank Fits All Models (Including Direct Vent)	17.80
C 9001583015	TP-103	2 1/2" Shank Fits All Models (Including Direct Vent)	19.00
C 9002403015	100 XL-2	3" Shank Fits All Models (Including Direct Vent)	21.00
F 9003741005	NCLX-5LX/LL100XL	A.G.A. rating, 200,000 BTUH ASME rating	18.00
A 9005903205		T & P Valve, 1-inch	124.80

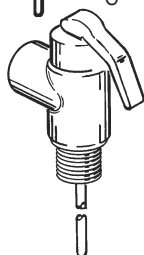
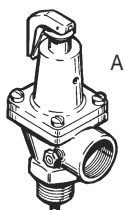
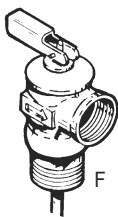

## COMMERCIAL ORIENTATION PRESSURE ONLY RELIEF VALVES

Part Number	Description	ASME	A.G.A.	List Price
C 9007111005	1", 150#, Pressure Relief Valve.	3,795,000	—	\$140.00
C 090917-003	3/4", 60#, Pressure Relief Valve.	415,000	—	80.00
C 090917-007	1", 65#, Pressure Relief Valve.	1,110,000	—	176.00
C 9006321005	3/4", 30#, Pressure Relief Valve.	480,000	—	76.60
C 097558-000	3/4", 125#, Pressure Relief Valve.	2,289,000	—	88.00
C 9006920005	3/4", 150#, Pressure Relief Valve.	2,703,000	—	88.00
C 9007370005	1" x 1 1/4", 30#, Pressure Relief Valve.	1,331,000	—	207.80

## DIP TUBES AND SPACERS

Part Number	Description	Overall Length (Inches)	List Price
E 9003918005	3/4" drop-in dip tube	26	\$13.00
E 9004938005	3/4" drop-in dip tube	36	13.80
E 9005885105	3/4" drop-in dip tube	45	13.60
E 9006254005	3/4" drop-in dip tube	52	12.60
NI 042589-000	5/16" thick spacer	—	3.40
NI 042589-001	5/8" thick spacer	—	3.40
NI 9001596005	PEX Dip Tube	52	12.60

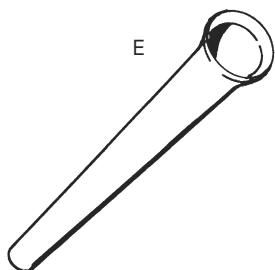

## T&P EXTENDER AND RUN OFF TUBES

Part Number	Description	Overall Length (Inches)	List Price
NI 9000398015	T & P extender, 3/4" x 3 1/4" zinc dichromate nipple w/polysulfone liner	—	\$23.60
NI 9005265115	T & P extender, 3/4" x 2" zinc dichromate nipple w/polysulfone liner	—	7.60
NI 9006196005	3/4" x 60" valve runoff tube	—	7.20
NI 9002273005	T&P Discharge Pipe (Sold in quantities of 10)	—	7.20

# RESIDENTIAL Installation Accessories

## INSTALLATION ACCESSORIES

Part Number	Model	Description	List Price
9000060015	FC-15	3/4" X 15" FLEXIBLE WATER CONNECTORS (sold in pairs)	\$ 39.00
9000511015	FC-18	3/4" X 18" FLEXIBLE WATER CONNECTORS (sold in pairs)	31.20
9000322015		3/4" X 2" PEXLINED NIPPLES (sold in pairs)	7.40
9002563015		3/4" X 2 1/2" PEXLINED NIPPLES (sold in pairs)	7.60
9002564015		3/4" X 3" PEXLINED NIPPLES (sold in pairs)	9.20
9002565015		1" X 2 1/2" PEXLINED NIPPLES (sold in pairs)	12.60
9000415015		SILENCER HEAT TRAPS (3/4" X 3"NIPPLES) (sold in pairs)	14.60
9000061015	IK-1/2	1/2" COMPRESSION FITTINGS (sold in pairs)	8.80
9000062015	IK-3/4	3/4" COMPRESSION FITTINGS (sold in pairs)	11.20
9850048000	ETC-2X	2 Gal. EXPANSION TANK (boxed)	92.00
9850049000	ETC-5X	5 Gal. EXPANSION TANK (boxed)	120.00
9850070000	ETC-10X	10 Gal. EXPANSION TANK (boxed)	254.00

## ALUMINUM WATER HEATER DRAIN PANS

Part Number	Description	List Price
9000741005	20" DRAIN PAN WITH 1" OUTLET (Up to 18" Diameter Heater)	\$32.40
9001609005	22" DRAIN PAN WITH 1" OUTLET (Up to 20" Diameter Heater)	38.40
9002769005	24" DRAIN PAN WITH 1" OUTLET (Up to 22" Diameter Heater)	43.00
9000743005	26" DRAIN PAN WITH 1" OUTLET (Up to 24" Diameter Heater)	53.40
9001608005	28" DRAIN PAN WITH 1" OUTLET (Up to 26" Diameter Heater)	54.60

## ELECTRIC INSTALLATION ACCESSORIES

Part Number	Description	List Price
9000104045	ELECTRIC INSTALLATION KIT	\$52.40
9001470005	CORD SET 240 VOLT	19.20
9003331205	(20-gal. max.) WALL MOUNT WATER HEATER STAND	83.20

Notes:

---



---



---



---

# Installation Accessories

RESIDENTIAL

RESIDENTIAL  
Installation Accessories

## GAS INSTALLATION ACCESSORIES

Part Number	Model	Description	List Price
9000105045		GAS INSTALLATION KIT	\$ 59.00
9000068015	GC-18	18" FLEXIBLE GAS LINE	14.80
9000894015		3" ADJUSTABLE GAS VENT EXTENDER	10.60
*9005743005		WATER HEATER STAND-22" X 22" X 16"	97.00
*9005744005		WATER HEATER STAND-24" X 24" X 18"	116.20
9003331205		(20-gal. max.) WALL MOUNT HEATER STAND	83.20
*NOTE: FOR COMPLIANCE WITH NATIONAL FUEL GAS CODE Z223.1 1980 SECTION 5.1.9 INSTALLATION IN RESIDENTIAL GARAGES.			

## DIRECT VENT INSTALLATION OPTIONS/ACCESSORIES (Legacy Direct Vent)

For Direct Vent Residential Water Heaters Only (Not for use with Manufactured Home Direct Vent System)

Kit Number	Horizontal or Vertical	Horizontal Range includes wall thickness 40-50 Gal.	40 Select	Vertical Range 50 Select (NBDS)	(Installed Hgt.) 50 Select (NODS)	75 Select	Approx. Shipping Weight	List Price
9001246005	Either	10-15 <sup>1</sup> / <sub>2</sub>	72-77 <sup>1</sup> / <sub>2</sub>	84 <sup>1</sup> / <sub>4</sub> -89 <sup>3</sup> / <sub>4</sub>	80 <sup>3</sup> / <sub>4</sub> -86 <sup>1</sup> / <sub>4</sub>	86 <sup>1</sup> / <sub>4</sub> -91 <sup>1</sup> / <sub>4</sub>	5	\$ 96.00
9001247005	Either	15 <sup>1</sup> / <sub>2</sub> -26 <sup>1</sup> / <sub>2</sub>	77 <sup>1</sup> / <sub>2</sub> -88 <sup>1</sup> / <sub>2</sub>	89 <sup>3</sup> / <sub>4</sub> -100 <sup>3</sup> / <sub>4</sub>	86 <sup>1</sup> / <sub>4</sub> -97 <sup>1</sup> / <sub>4</sub>	91 <sup>1</sup> / <sub>4</sub> -102 <sup>1</sup> / <sub>4</sub>	9	96.00
9001248005	Either	26 <sup>1</sup> / <sub>2</sub> -48	88 <sup>1</sup> / <sub>2</sub> -110	100 <sup>3</sup> / <sub>4</sub> -122 <sup>1</sup> / <sub>4</sub>	97 <sup>1</sup> / <sub>4</sub> -118 <sup>3</sup> / <sub>4</sub>	102 <sup>1</sup> / <sub>4</sub> -124 <sup>1</sup> / <sub>4</sub>	15	155.20
9000687005	Horizontal	3 <sup>1</sup> / <sub>2</sub> -10	N/A	N/A	N/A	N/A	5	53.20
9000915005	PROTECTOR GRILL FOR DIRECT VENT							88.20
9002749005	DELUXE VENT KITS SQUARE ALUM 40/50/75 RES PVDV							273.40
9003328005	DELUXE VENT KITS ROUND PORCELAIN 40/50/75 RES PVDV							318.00

## MANUFACTURED HOME DIRECT VENT INSTALLATION

Part Number	Description	List Price
9002964005	NON-ADJUSTABLE ROOF JACK-12" (boxed)	\$169.80
9002965005	ADJUSTABLE ROOF JACK- 12" TO 32" (boxed)	221.20
9002966005	ADJUSTABLE ROOF JACK- 32" TO 60" (boxed)	267.60
9002967005	ADJUSTABLE ROOF JACK- 60" TO 95" (boxed)	388.40

Notes:

---



---



---



---



---

# Flanged Elements & Thermostats

## FLANGED INCOLOY ELEMENTS

Part Number	Volts	KW	Max "A" Dim. (Inches)	List Price
B 9004832105	208	5	9 1/2	\$340.60
B 9004836105	208	6	12	348.60
B 9004837105	208	7.5	14 1/2	371.20
B 9004839105	208	10	15 1/2	371.20
B 9004841105	208	12	15 1/2	371.20
B 9004842105	208	15	15 1/2	371.20
B 9004833105	208	15	22	413.60
B 9004834105	208	18	15 1/2	371.20
B 9004835105	208	3	9 1/2	371.20
B 9004846105	240	3	9 1/2	340.60
B 9004847105	240	5	9 1/2	340.60
B 9004848105	240	6	12	356.40
B 9004849105	240	7.5	14 1/2	371.20
B 9004850105	240	9	15 1/2	371.20
B 9004851105	240	10	15 1/2	354.00
B 9004852105	240	12	15 1/2	371.20
B 9004843105	240	15	15 1/2	371.20
B 9004844105	240	15	22	416.20
B 9004845105	240	18	15 1/2	371.20
A 9004853105	480/277	2	9 1/2	340.60
A 9004858105	480/277	3	9 1/2	340.60
A 9004859105	480/277	5	9 1/2	371.20
A 9004860105	480/277	6	12	356.40
A 9004861105	480/277	7.5	14 1/2	371.20
A 9004865105	480/277	9	15 1/2	371.20
A 9004866105	480/277	10	15 1/2	371.20
A 9004867105	480/277	12	15 1/2	371.20
A 9004854105	480/277	15	16 1/2	371.20
A 9004855105	480/277	15	22	413.60
A 9004856105	480/277	18	15 1/2	371.20
A 9004857105	480/277	7.5	22	413.60
B 9004868105	480	6	12	356.40
B 9004869105	480	9	15 1/2	371.20
B 9004870105	480	12	15 1/2	371.20
B 9004871105	480	18	15 1/2	371.20
B 9004872105	480	15	17 1/2	413.60

## FEATURES & BENEFITS

- Used on DSE, CMC, SU & DVE/DHE models over 125 gallons
- Incoloy nickel-alloy sheathing
- Medium watt density
- For commercial use. Includes gasket
- For 2 1/2" bolt-circle, round and square flanges
- Strong, forged steel flanges

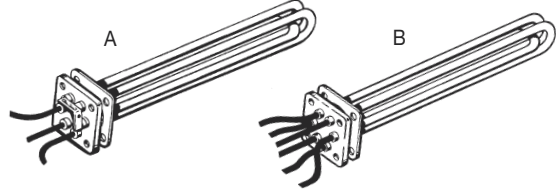
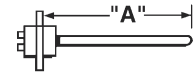

## ELECTRIC THERMOSTATS

Part Number	Description	List Price
C 9004769105	Single pole, double throw immersion thermostat, temperature range 140°F to 194°F.	\$289.00
D 9005078205	Single pole, single throw, remote bulb, immersion thermostat, temperature range 60°F to 200°F.	206.80
9005714005	3/4" NPT well. Included with 9005078205 thermostat.	85.00
E 9004969215	Single pole, single throw surface mounted thermostat; adjustable 120°F to 180°F. Double pole, single throw, manual reset high limit, cutout -200°F. Style 4401 series 59/66T.	47.80
F 9004533215	Single pole double throw thermostat - w/high limit incorporated as one piece adjustable 120°F to 180°F. Type 89T13.	37.40

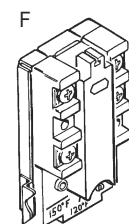
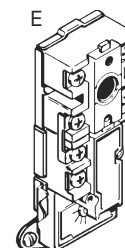
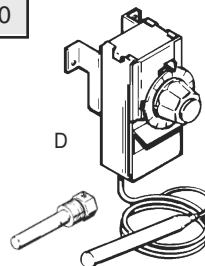
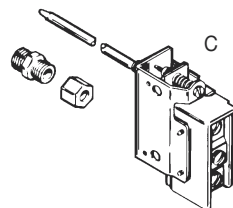

# Igniters & Temperature Controls

## HOT SURFACE IGNITERS

Part Number	Description	List Price
N 9006101205	Igniter	\$120.00
Q 9005902215	Igniter	132.60
NI 9004566115	Igniter	164.40
R 9004572205	Silicon Nitride Igniter	62.80
S 9004238215	Upper Probe Assembly	85.20
S 9004241215	Lower Probe Assembly	69.60

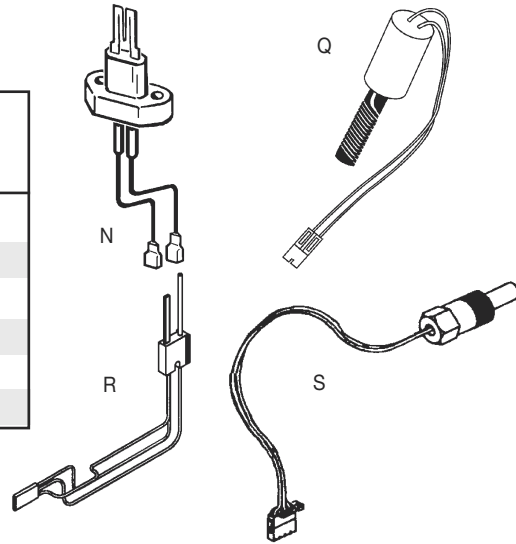

## MANUAL AND AUTOMATIC TEMPERATURE CONTROLS

Part Number	Description	Tank Opening Size (Inches)	Adjustable Temperature Range -°F (Differential)	Fixed Temperature High Limit		List Price
				Open	Close	
J 9004968105	Automatic reset limit. Includes 5091 lower well and 5090 top well.	3/4	100-180 (Diff. 4)	195	120	\$320.80
J 9004531205	Manual reset limit, direct immersion.	3/4	120-180 (Diff. 4)	195	120	344.60
J 9004975105	Automatic reset limit, direct immersion.	3/4	120-180 (Diff. 4)	195	120	312.80
J 9004529005	Manual reset, dual control.	3/4	120-180 (Diff. 4)	205	125	291.60
K 9005044205	Automatic reset limit. Includes 9005078205 well.	3/4	100-240 (Diff. 5-45)	N/A	N/A	185.60
M 9004793105	Direct Immersion.	1/2	100-240 (Diff. 10-45)	N/A	N/A	249.20
M 9004506205	Dual Control -					528.80
M 9005925205	Tank Temp.	3/4	100-240 (Diff. 5)	N/A	N/A	240.00

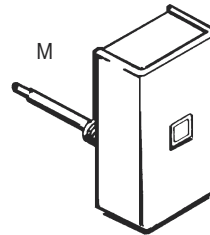
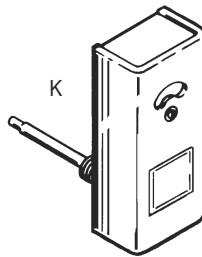
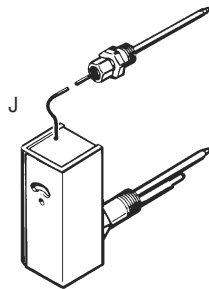

Notes:

---



---



---



# COMMERCIAL

## Contactors/Transformers/High Limit Controls

COMMERCIAL Contactors/Transformers/High Limit Controls

### CONTACTORS

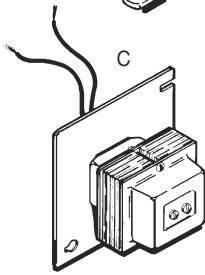
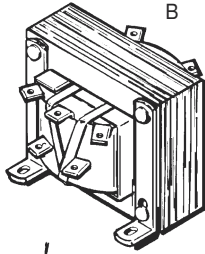
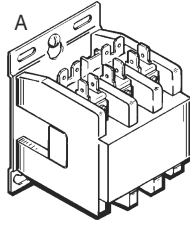

Part Number	Description	List Price
A 9004816105	50* Amp, 120 Volt, three pole contactor.	\$ 84.00
A 9004817105	50* Amp, 120 Volt, four pole contactor.	263.80
A 9005434105	50* Amp, 208/240 Volt, three pole contactor.	185.60
A 9005013205	30* Amp, 120 Volt, three pole contactor.	103.20

\*Resistive amps

### TRANSFORMERS

Part Number	Description	Primary (Line Voltage)	Secondary (Control Circuit Voltage)	List Price
B 9004830105	Transformer	208/240/480	120	\$250.40
B 9006861005	Transformer	208/240/277/480	120	232.20
B 9005078205	Transformer	240/480	120/240	206.80
C 9005916205	Plate mounted transformer	120	25	58.00
D 9005901205	Transformer	24 VAC	—	37.00

\*Not Illustrated

### HIGH LIMIT CONTROLS

Part Number	Description	List Price
D 9004770105	Single pole, double throw immersion high limit control, manual reset, non-adjustable cutout - 200°F.	\$291.60
E 9004961205	Single pole, single throw, remote bulb, immersion high limit control, manual reset, non-adjustable cutout - 200°F.	210.80
G 9004993215	Single pole, single throw surface mounted high limit control, manual reset, non-adjustable cutout - 255°F. Used on copper heat exchanger models.	28.20

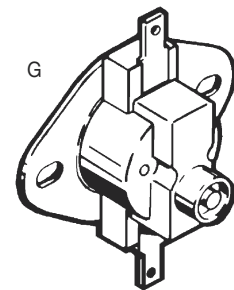
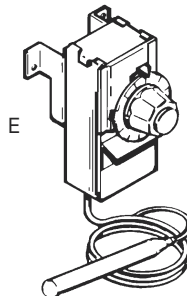
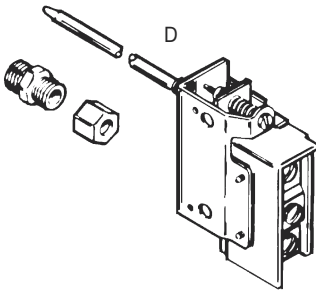

# Gas Valves

# COMMERCIAL

# Gas Valves

## GAS VALVES

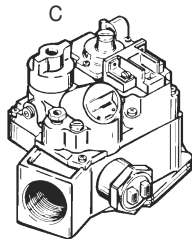
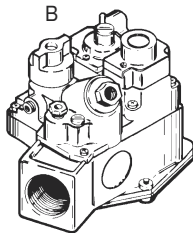
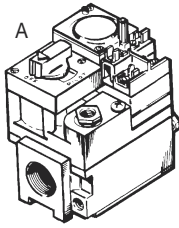

Part Number	Description	List Price
A 9004806105	3/4" NATURAL gas, step opening gas valve, 750 millivolt, 3.5" adjustable main pressure regulator setting.	\$353.20
A 9004807105	3/4" PROPANE gas, step opening gas valve, 750 millivolt, 10.5" adjustable main pressure regulator setting.	417.80
B 9004527205	3/4" NATURAL gas, slow opening gas valve, 24 Volt, 3.5" adjustable main pressure regulator setting.	278.00
B 9004528205	3/4" PROPANE gas, slow opening gas valve, 24 Volt, 11" adjustable main pressure regulator setting.	278.00
C 9005017205	1" NATURAL gas, slow opening gas valve, 24 Volt, 3.5" adjustable main pressure regulator setting.	521.60
C 9005018205	1" PROPANE gas, slow opening gas valve, 24 Volt, 11" adjustable main pressure regulator setting.	553.60
NI 078481-002	1" NATURAL gas	585.60
NI 078482-001	1 1/4" NAT./PROP. gas	797.20
NI 9004495205	1" PROPANE gas	623.20
NI 9004496205	1" NATURAL gas	628.60
NI 9004497205	3/4" NATURAL gas	390.80
NI 9004995205	3/4" NATURAL gas	397.80
NI 9004551205	1" NATURAL gas	555.60
NI 9007398005	1" PROPANE gas	512.00
NI 9004507205	3/4" NATURAL gas	206.80
NI 9007181005	3/4" NATURAL gas	159.00
NI 9004521205	3/4" NATURAL gas	250.40
NI 9004535205	1/2" NATURAL gas	214.20
NI 9004582205	3/4" NATURAL gas	247.60
NI 9004583205	3/4" PROPANE gas	253.20

NI- Not illustrated.

## LIGHT COMMERCIAL GAS VALVES

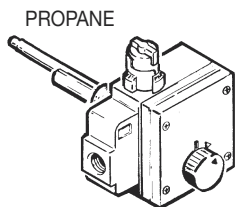
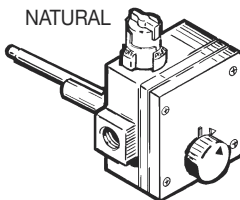

Part Number	Description	List Price
9005891105	NATURAL gas, 96,000 Btuh maximum capacity, 4" main pressure regulator setting, 3" to 4" pilot pressure, energy cutoff at 195°F water temperature, range; warm (120°F) to hot (180°F).	\$142.00
9004812105	PROPANE gas, 150,000 Btuh max. cap., 10" main pressure regulator setting; 10" to 12" pilot pressure plus gas inlet screen and baffle, energy cutoff at 195°F water temperature, range; warm (120°F) to hot (180°F). RIGHT HAND THREAD BURNER TUBE CONNECTION.	267.60
9004493105	PROPANE gas, 150,000 Btuh max. cap., 10" main pressure regulator setting; 10" to 12" pilot pressure plus gas inlet screen and baffle, energy cutoff at 195°F water temperature, range; warm (120°F) to hot (180°F). LEFT HAND THREAD BURNER TUBE CONNECTION.	250.40

\*Order for replacement on propane heaters manufactured after January 1, 1993.

# COMMERCIAL

## Pilot Burners & I.I.D. Controls

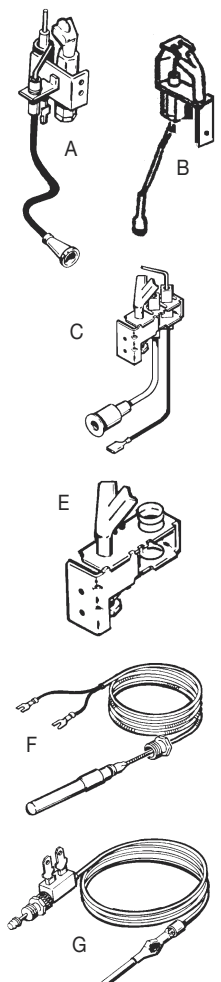

### JOHNSON, HONEYWELL, WHITE RODGERS, ROBERTSHAW and More

Part Number	Description	List Price
A 9005029115	Johnson pilot burner, natural gas, for use on I.I.D. model heaters.	\$129.40
A 9005030115	Johnson pilot burner, propane gas, for use on I.I.D. model heaters.	129.40
A 9005031115	Pilot sensing probe used with 78700 and 78700-1 pilot burners.	25.80
B 9004998215	Honeywell pilot burner	76.20
B 9004999215	Honeywell pilot burner	76.20
B 9005000215	Honeywell pilot burner	76.20
B 9005001215	Honeywell pilot burner	76.20
B 9004542215	Propane pilot burner for BTC-120 thru 500A series 970 and up.	63.00
B 9004541215	Natural pilot burner for BTC-120 thru 500A series 970 and up.	63.00
C 9004988115	White Rodgers pilot burner, natural gas, for use on I.I.D. model heaters	96.80
C 9004989115	White Rodgers pilot burner, propane gas, for use on I.I.D. model heaters.	96.80
F 9005043115	750 millivolt thermopile, 32" long.	50.40
G 9004771115	30 millivolt thermocouple, 36" long with junction block.	21.80
NI 9003925115	60" length of aluminum tubing. Use when tubing has been damaged or is too short after control replacement.	21.60
NI 099041-000	Relight standing gas pilots	258.00
NI 9004534215	Robertshaw pilot burner, natural gas, for use on BTC models series 962	38.60
NI 9004532215	Robertshaw pilot burner, propane gas, for use on BTC models series 963	39.80

NI-Not illustrated

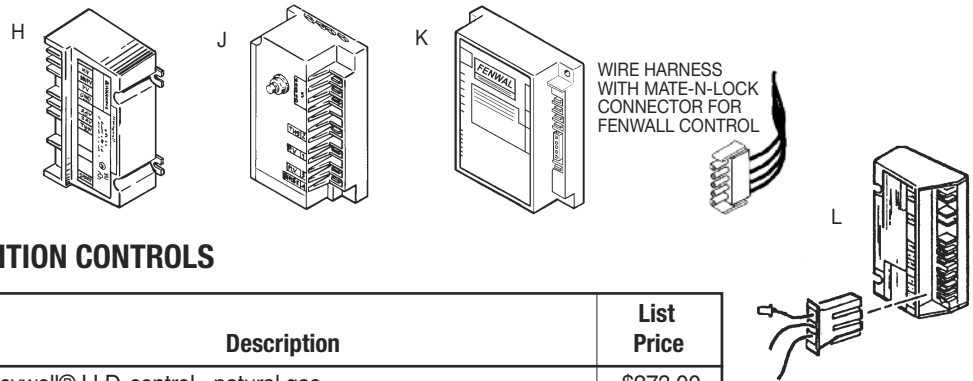

### INTERMITTENT IGNITION CONTROLS

Part Number	Description	List Price
H 9004996105	Honeywell® I.I.D. control - natural gas	\$273.00
H 9004997105	Honeywell® I.I.D. control with lockout - propane gas	273.00
J 9004470205	Johnson® I.I.D. control - natural gas	196.00
K 9004487105	Fenwall® I.I.D. control with wire harness(6594 & 6594-1) for all BTP-540A or 700A series	551.40
L 9004544205	Honeywell® I.I.D. control - nat. & prop. for BTC 120 thru 500A series 970 and up	177.20
L 9004951205	Honeywell® Upgrade Kit for BTC models-nat. & prop.	177.60
M 9004492005	Ram H.S.I Control - Standard Legend Models	502.20
NI 9004477205	Honeywell I.I.D. control - natural gas	371.20
NI 9004525105	Johnson (G-67) I.I.D. control - natural gas	283.60

NI-Not illustrated

# Flue Dampers, Coils & Heat Exchangers

COMMERCIAL

## MOTORIZED FLUE DAMPER

Part Number	Description	List Price
A 9005994105	Flue Damper 6"	\$837.60
A 9005995105	Flue Damper 8"	901.40
NI 9005934205	Draft Hood Assembly	138,00
NI 9005926205	Draft Hood Assembly	165.60

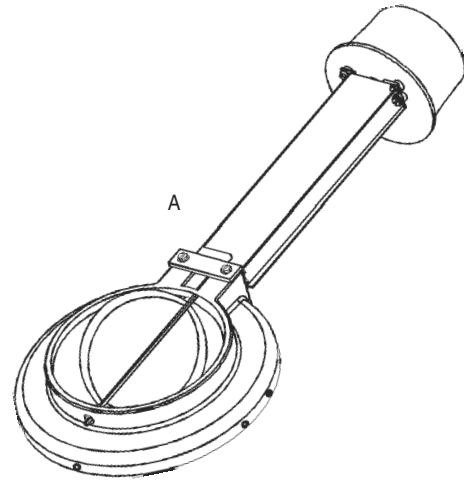

## NEW MOTORIZED FLUE DAMPER

Part Number	Description	List Price
NI 9005738005	NEW—Damper Service Kit— Contains the damper module for repair and an instruction sheet	\$470.00

## COILS & HEAT EXCHANGERS

Part Number	Description	List Price
A 9005061205	BC-120	\$1,709.80
A 9004472205	HW-120M thru HW-225M	2,420.20
A 9005058205	BC-160/BC-200 & BC-225	2,770.00
A 9005046205	HW-300	2,950.40
A 9005082205	HW-520 & HW-670	3,451.20
A 9005083205	BC-670	3,451.20
A 9005084205	HW-1240 & HW-1340	3,878.00
B 9005068205	HW-80P/HW-100P	1,831.60
B 9005070205	HW-200P & HW-225	2,314.00
B 9005066205	HW-120M & HW-160M	1,952.20
B 9005067205	BC-200 & BC-225 - HW-200M & HW-225M	2,437.40
B 9005073205	HW-300	1,865.20
B 9005074205	HW-399 & HW-420	2,438.00
B 9005090205	HW-520 & HW-670	2,733.80
B 9005091205	HW-670	3,265.80

DIRECT FACTORY  
REPLACEMENT  
COPPER, BRASS  
AND  
BRONZE  
CONSTRUCTION

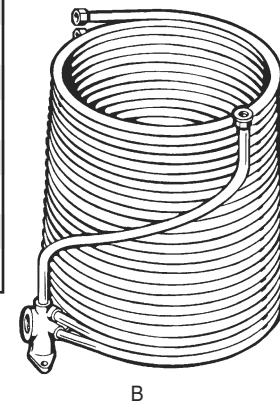

NOTE: Models shown are for quick reference only. To verify part numbers, check model & series number of heater in appropriate parts list.

Additional parts necessary to change from lead dipped to integral finned are included.

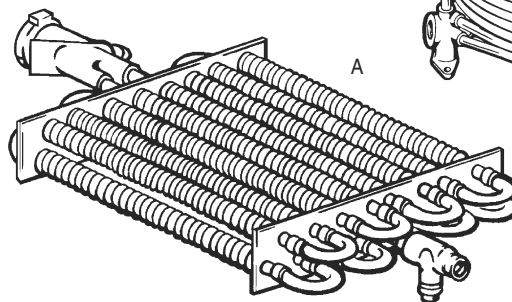

Flue Dampers, Coils & Heat Exchangers

# COMMERCIAL Pumps

## BELL & GOSSETT (BRONZE)

Part Number	Bell & Gossett Bronze Body Pumps & Pump Shut-Off Delay Used For Domestic Hot Water Applications	List Price
9005054105	2" All Bronze Pump.	\$2,410.00
9005093105	1" HV Bronze Pump - NFI.	1,748.00
9004918105	1 1/2" HV Bronze Pump - NFI.	1,748.00
9004922105	No. 100 1" STD All Bronze Pump.	1,078.00
9005034105	No. 125 1 1/4" STD All Bronze Pump.	1,078.00
9005036105	No. 150 1 1/2" STD All Bronze Pump.	1,078.00
9005038105	2 1/2" All Bronze Pump	3,662.00
9005041105	No. 75 All Bronze Pump.	1,078.00
9005050105	1 1/4" HV Bronze Pump - NFI.	1,748.00
095600-000	3" HD3B All Bronze Pump.	4,234.00

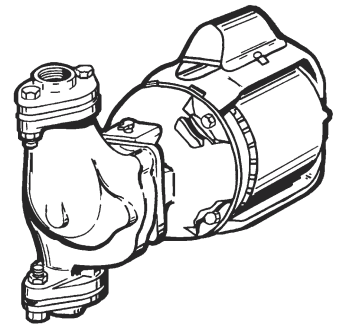

## TACO (BRONZE)

Part Number	TACO Bronze Body Pumps Used For Domestic Hot Water Applications	List Price
9005055205	2" All Bronze Pump 1/7 HP.	\$931.80
9005094205	1" All Bronze Pump 1/7 HP.	851.00
9004919205	1 1/2" All Bronze Pump 1/7 HP.	851.00
9005035205	1 1/4" All Bronze Pump 1/15 HP.	649.40
9005037205	1 1/2" All Bronze Pump 1/15 HP.	649.40
9005042105	3/4" All Bronze Pump 1/25 HP.	469.20
9004919205	Bronze Pump 1/8 HP	851.00

## THERMAL BALANCER

Part Number	Description	List Price
9005908205	Thermal Balancer (pump shut-off delay switch).	\$198.00

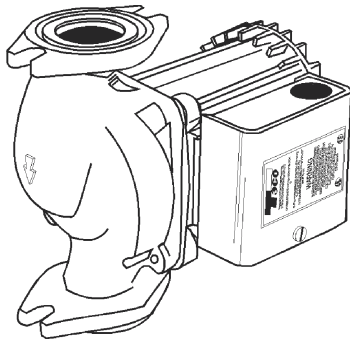

Part Number	Iron Body Pumps used for Hydronic Heating Applications	List Price
9004965205	1 1/4" No. 125 B & G Iron Body Pump.	\$ 616.00
069947-002	2 1/2" B & G Iron Body Pump.	1,892.60

Part Number	Used For Domestic Water Applications	List Price
9004631205	Pump Kit used on LW Model 500 series 920 - 951	\$2,475.80
9004632205	Pump Kit used on LW Model 750 series 920 - 951	4,031.80

# System Packages

# COMMERCIAL

# System Packages

## CER-TEMP ONE HEATER \*PACKAGES

CER-TEMP ONE HEATER *PACKAGES		
Part Number	B&G Part Number	List Price
9004896105	6291-10	\$1,756.00
9004899105	6291-11-A	1,804.00
9004902105	6291-12-A	1,844.00
9004905105	6291-13-A	3,016.00
9004908105	6291-14-A	3,626.00

\*Packages contain Bell & Gossett Circulating Pump

CER-TEMP ONE HEATER *PACKAGES		
Part Number	TACO Part Number	List Price
9004897105	6291-10-T	\$1,164.00
9004900105	6291-11-A-T	1,172.00
9004903205	6291-12-A-T	1,394.00
9004906205	6291-13-A-T	1,526.00
9004909205	6291-14-A-T	1,630.00

\*Packages contain TACO Circulating Pump

- PACKAGE CONTENTS:**
- Qty 2 Description Straight Thermometers
  - 1 Angle Thermometer
  - 1 Wall Type Junction Box
  - 1 Tank Temperature Control
  - 1 Safety Flow Switch

## CER-TEMP TWO HEATER \*PACKAGES

CER-TEMP TWO HEATER *PACKAGES		
Part Number	B&G Part Number	List Price
9004917105	6292-9	\$2,146.00
9004910105	6292-10-A	3,076.00
9004912105	6292-11-A	3,914.00
9004915105	6292-12-A	4,432.00

\*Packages contain Bell & Gossett Circulating Pump

CER-TEMP TWO HEATER *PACKAGES		
Part Number	TACO Part Number	List Price
9004924105	6292-9-T	\$1,516.00
9004911205	6292-10-A-T	2,044.00
9004913205	6292-11-A-T	2,048.00
9004916205	6292-12-A-T	4,634.00

\*Packages contain TACO Circulating Pump

- PACKAGE CONTENTS:**
- Qty 3 Description Straight Thermometers
  - 1 Angle Thermometer
  - 1 Wall Type Junction Box
  - 1 Tank Temperature Control
  - 2 Safety Flow Switches

## SHURE-TEMP ONE HEATER \*PACKAGES

SHURE-TEMP ONE HEATER *PACKAGES		
Part Number	B&G Part Number	List Price
9004925105	6293-10-A	\$2,368.00
9004926105	6293-11-A	2,470.00
9004927105	6293-12-A	2,774.00
9004929105	6293-13-A	3,174.00

\*Packages contain Bell & Gossett Circulating Pump

SHURE-TEMP ONE HEATER *PACKAGES		
Part Number	B&G Part Number	List Price
9004928205	6293-12-A-T	\$1,836.00
9004930205	6293-13-A-T	1,936.00

\*Packages contain TACO Circulating Pump

- PACKAGE CONTENTS:**
- Qty 1 Description Straight Thermometer
  - 2 Angle Thermometers
  - 1 Wall Type Junction Box
  - 1 Line Temperature Control
  - 1 Dual Temperature Control
  - 1 Tank Temperature Control
  - 1 Safety Flow Switch
  - 1 Pressure Relief Valve



# COMMERCIAL

## VF & GW Venting

# VF & GW Venting

Description	4" GW Models		5" GW Models		6" GW/VF Models		7" GW Models		8" GW Models	
	Part Number	List Price	Part Number	List Price	Part Number	List Price	Part Number	List Price	Part Number	List Price
NI Exhaust Vent Cover (Genesis Only)	9005211205	\$58.00	9005402205	\$60.00	9005212205	\$60.00	—	—	9005213205	\$68.00
A Vent Terminal-Horizontal (Legend Only)	210371-000	154.00	210371-001	186.00	210371-002	282.00	—	—	210371-003	396.00
B Vent Terminal-Vertical	—	—	—	—	191960-000	474.00	191960-001	1,416.00	—	—
D 6" Length Pipe	191777-002	132.00	191777-003	222.00	191777-000	268.00	191777-001	224.00	191777-001	224.00
D 12" Length Pipe	192039-014	40.00	192039-019	38.00	192039-004	42.00	192039-009	68.00	192039-024	44.00
D 18" Length Pipe	192039-013	44.00	192039-018	48.00	192039-003	58.00	192039-008	78.00	192039-023	64.00
D 2' Length Pipe	9005863105	90.00	9005658105	76.00	9005659105	78.00	9005660105	102.00	9005661105	116.00
D 37.5" Length Pipe	192039-012	76.00	192039-017	82.00	9005919005	94.00	192039-007	114.00	192039-022	128.00
Vent 4"X 37.5"	192039-011	110.00	192039-016	112.00	9005935205	118.00	9005684205	156.00	192039-021	182.00
K 18" Length Slip Connector (Adjustable Pipe)	9005662105	66.00	9005663105	90.00	9005656105	78.00	9005657105	84.00	9005664105	100.00
C 45 Degree Elbows	9005665105	110.00	9005666105	114.00	192031-000	151.80	9005682205	178.00	9005667105	160.00
C 90 Degree Elbows	192032-002	132.00	192032-003	148.00	192032-000	148.00	9005687205	196.00	192032-004	248.00
NI In-line Drain Section 9" Length	210414-000	100.00	210414-001	106.00	210414-002	100.00	210414-003	106.00	210414-004	126.00
F Boot Tee	9005668105	190.00	9005669105	198.00	192034-000	254.00	192034-001	296.00	9005673105	298.00
G Condensate Drain Cover	9005864105	48.00	9005670105	52.00	192036-000	180.00	192036-001	66.00	9005674105	68.00
H Wall Cover Plate	9005375205	26.00	9005378205	26.00	9005376205	26.00	9005377105	16.00	9005133205	16.00
J Roof Jack Support System	192076-002	340.00	192076-003	392.00	192076-000	404.00	192076-001	480.00	192076-004	530.00
L Flex Adapter Coupling (Use with PVC pipe only)	191967-000	38.00	9005671105	50.00	191967-001	52.00	191967-002	58.00	—	—
NI Vent Support	500646-000	184.00	—	—	9005672105	206.00	500817-000	304.00	—	—
NI No. 76 Patch Kit	9005283205	26.00	9005283205	26.00	9005283205	26.00	9005283205	26.00	9005283205	26.00
NI Sealant (General Electric RTV-106) 3 oz Tube	191482-001	38.00	191482-001	38.00	191482-001	38.00	191482-001	38.00	191482-001	38.00

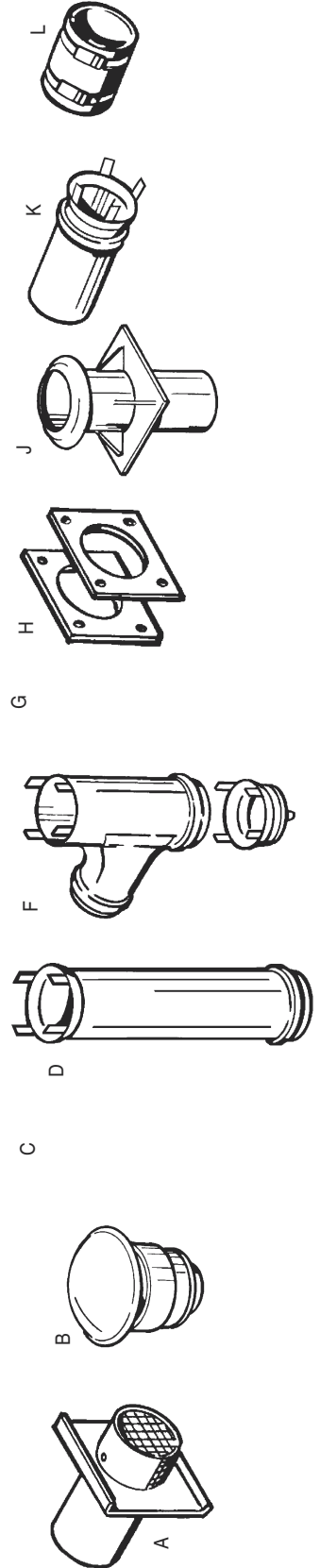



# Accessories & Tools

COMMERCIAL

Accessories & Tools  
COMMERCIAL

## PRESSURE GAUGE KITS TO WIRELESS WATER DETECTIVE

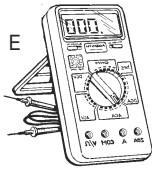
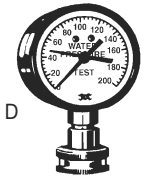
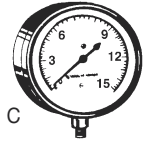

Part Number	Description	List Price
C 9005033105	GAS PRESSURE GAUGE KIT Includes fittings to check main and pilot pressures. Range of 0" to 15" water column for use on natural and propane gas. Complete with adapters and hose for easy attachment to control or manifold.	\$171.00
D 9004792105	WATER PRESSURE GAUGE KIT Includes brass reducer and 3/4" female hose fitting. Pressure range from 0 to 200 pounds. 2 1/2" dial face with red maximum indication pointer.	132.40
E 9004653105	DIGITAL MULTIMETER An A.O. Smith exclusive, does 5 essential tests; OHM resistance, DC voltage, AC voltage, AC amperage, DC microamps and more. Large 1" digit readout, test leads and instructions.	296.80
F 9005405105	WIRELESS WATER DETECTIVE The wireless water damage alarm is an early warning alarm system that alerts you to any unwanted water due to flooding and other water related damages.	78.80

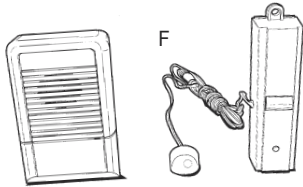

## SERIES CA-6100 CA-CALC COMBUSTION ANALYZERS

Part Number	Description	List Price
9005767105	Combustion Analyzer, w/carrying case O2, CO, Flue & Air Temperature and draft measuring gas analyzer w/probe with thermocouple, water trap with filter, 4 AA Alkaline batteries, Operation and Service Manual, carrying case, power supply, printer and printer charger	\$4,945.20
9005768105	Combustion Analyzer, O2, CO, Flue & Air Temperature and draft measuring gas analyzer w/probe with thermocouple, water trap with filter, 4 AA Alkaline batteries, Operation and Service manual.	2,112.60

### Check out these great features:

- Quality service
- Large display and intuitive operation
- Real-time data provides quick tuning feedback
- 10-hour battery life lowers operating costs
- Automatic base line calibration of sensors
- Recalibrates easily for critical safety checks
- Quick new sensor installation
- Heavy-duty pump designed for field service

These portable combustion analyzers are ideal for light commercial to residential applications. Boiler service professionals are provided flue gas data to tune burners on boilers and other heating appliances for safe, efficient operation.

# COMMERCIAL

## Accessories & Tools

### SEQUENCING /RESETTING CONTROL PANELS

Part Number	Description	List Price
NI 9005409105	262 -TEK 2-Stage DB-HW/Boiler Tekmar® Control	\$1,800.00
NI 9005410105	264 -TEK 4-Stage DB-HW/Boiler Tekmar® Control	2,759.20
NI 9005408105	258 -TEK 8-Stage DB-DW/Boiler Tekmar® Control	2,880.00

Tekmar® control panels. NI-Not illustrated.

### THERMOMETERS

Part Number	Description	List Price
D 9005423105	Max. Registering Service Thermometer, Temp. Range 0°F - 220°F, Mercury Fill.	\$167.00
D 9005424105	General Testing Service Thermometer, Temp. Range 0°F - 220°F, Liquid Fill.	78.20
E 9005922105	1/2" NPT, Brass Well, Straight Thermometer, Temp. Range 40°F - 260°F, Liquid Fill.	88.00
F 093155-000	1/2" NPT, Brass Well, Angle Thermometer, Temp. Range 40°F - 260°F, Liquid Fill.	90.00

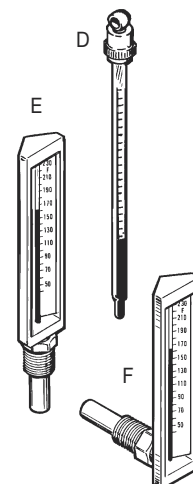

### SAFETY FLOW SWITCHES, LOW WATER CUT-OFFS & ACCESSORIES

Part Number	Description	List Price
9005541105	Penn F61-KD4 Low Flow Rate 3/4" x 3/4" Safety Flow Switch. HW-120M/160M.	\$328.00
9005645105	Penn F61-KD3 1/2" Safety Flow Switch. Dishwasher rinse line.	352.00
M 9005545105	Four piece replacement paddle kit for use with 78168 only. HW-200 and up.	28.60
N 210175-000	Low water cut-off - Automatic reset	470.00
N 210175-001	Low water cut-off - Manual reset	520.00

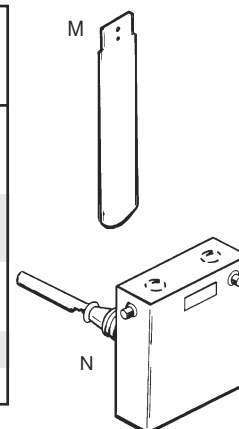

### SAFETY FLOW SWITCH REDUCING TEE PACKAGES

Part Number	Description	List Price
NI 9005025115	1" Sweat x 1" Sweat x 1" NPT Reducing Tee for use with 78168 only.	\$108.00
NI 9005026115	1 1/4" Sweat x 1 1/4" Sweat x 1" NPT Reducing Tee for use with 78168 only.	130.00
NI 9005027115	1 1/2" Sweat x 1 1/2" Sweat x 1" NPT Reducing Tee for use with 78168 only.	102.00
NI 9005028115	2" Sweat x 2" Sweat x 1" NPT Reducing Tee for use with 78168 only.	172.00
NI 078542-000	2 1/2" NPT x 2 1/2" NPT x 1" NPT Reducing Tee for use with 78168 only.	538.00

NI-Not illustrated.

# Deliming Accessories & Tools

COMMERCIAL  
Deliming Accessories & Tools

## UN•LIME® NON MURATIC DELIMER

Part Number	Description	List Price
9005416105	1 Gallon size, plastic, case of four (4).	\$360.20
9005417105	5 Gallon size, plastic, (1) one per case.	370.40
<ul style="list-style-type: none"> <li>• For all water heaters, heating, cooling, evaporation &amp; humidification equipment.</li> <li>• Powerful, patented A.O. Smith UN•LIME® is ready to use without mixing or diluting.</li> </ul>		

## UP-N-DOWN® GRAVITATIONAL DELIMING KIT WITH UN•LIME® DELIMER FOR USE IN GAS, OIL & ELECTRIC TANK TYPE WATER HEATERS

Part Number	Description	List Price
9004876115	Stopper Kit for heavy deliming boilers	\$106.00

## MAG-ERAD® NON-TOXIC CLEANER FOR NOISY TANK TYPE RESIDENTIAL GAS WATER HEATERS & TANKLESS

Part Number	Description	List Price
<ul style="list-style-type: none"> <li>• In concentrated powder form</li> <li>• No special equipment required</li> <li>• Minimum 2-1Lb. cans for 30 to 40 gallon size heaters, more required for larger sizes.</li> </ul>		
9005413105	1 Lb. can of Mag-Erad®	\$39.20
9005778105	12-1Lb. cans of Mag-Erad®	318.20

Notes:

---



---



---



---



---

## GENERAL PARTS 60-120 BTH/SUF/HCG

Item No.	Description	Kit #	UPC Code	Qty.	List Price
1	T & P Valve	9005903205	0 20363 13503 4	1	\$124.80
2	Lower Probe	9006242015	0 20363 15050 1	1	116.60
3	User Interface Module – UIM	9006240005	0 20363 15598 8	1	258.00
	Controller (natural)	9006838005	0 20363 16191	1	535.40
4	Controller (propane)	9006842005	0 20363 31619 8	1	535.40
5	Switch-prover (natural & propane)	9006280015	0 20363 15638 1	1	80.80
6	Switch-inlet (natural)	9006288015	0 20363 15646 6	1	80.80
6	Switch-inlet (propane)	9006281015	0 20363 15639 8	1	80.80
7	Switch-blocked outlet (natural & propane)	9006287015	0 20363 15645 9	1	80.80
8	Upper Probe (natural & propane)	9004238215	0 20363 13503 4	1	85.20

## GENERAL PARTS 100-150 BTH/SUF/HCG

Item No.	Description	Kit #	UPC Code	Qty.	List Price
1	T & P Valve	9005903205	0 20363 13503 4	1	\$124.80
2	Lower Probe	9006242015	0 20363 15050 1	1	116.60
3	User Interface Module – UIM	9006240005	0 20363 15598 8	1	258.00
4	Controller (natural)	9006839005	0 20363 16192 7	1	535.40
4	Controller (propane)	9006843005	0 20363 31616 5	1	535.40
5	Switch-prover (natural & propane)	9006280015	0 20363 15638 1	1	80.80
6	Switch-inlet (natural)	9006288015	0 20363 15646 6	1	80.80
6	Switch-inlet (propane)	9006281015	0 20363 15639 8	1	80.80
7	Switch-blocked outlet (natural)	9006289015	0 20363 15647 3	1	80.80
7	Switch-blocked outlet (propane)	9006287015	0 20363 15645 9	1	80.80
8	Upper Probe (natural & propane)	9004238215	0 20363 13503 4	1	85.20

Notes:

---



---



---



---



---

# High Efficiency

# COMMERCIAL

# COMMERCIAL

High Efficiency

## GENERAL PARTS 100-199 BTH/SUF/HCG

Item No.	Description	Kit #	UPC Code	Qty.	List Price
1	T & P Valve	9005903205	0 20363 13503 4	1	\$124.80
2	Lower Probe	9006242015	0 20363 15050 1	1	116.60
3	User Interface Module – UIM	9006240005	0 20363 15598 8	1	258.00
4	Controller (natural)	9006840005	0 20363 16193 4	1	535.40
4	Controller (propane)	9006844005	0 20363 16197 2	1	535.40
5	Switch-prover (natural & propane)	9006280015	0 20363 15638 1	1	80.80
6	Switch-inlet (natural)	9006288015	0 20363 15646 6	1	80.80
6	Switch-inlet (propane)	9006281015	0 20363 15639 8	1	80.80
7	Switch-blocked outlet (natural)	9006289015	0 20363 15647 3	1	80.80
7	Switch-blocked outlet (propane)	9006282015	0 20363 15640 4	1	80.80
8	Upper Probe (natural & propane)	9004238215	0 20363 13503 4	1	85.20

## GENERAL PARTS 100-250 BTH/SUF/HCG

Item No.	Description	Kit #	UPC Code	Qty.	List Price
1	T & P Valve	9005903205	0 20363 13503 4	1	\$124.80
2	Lower Probe	9006242015	0 20363 15050 1	1	116.60
3	User Interface Module – UIM	9006240005	0 20363 15598 8	1	258.00
4	Controller (natural)	9006841005	0 20363 16194 1	1	535.40
4	Controller (propane)	9006845005	0 20363 16198 9	1	535.40
5	Switch-prover (natural & propane)	9006280015	0 20363 15638 1	1	80.80
6	Switch-inlet (natural & propane)	9006281015	0 20363 15639 8	1	80.80
7	Switch-blocked outlet (natural & propane)	9006282015	0 20363 15640 4	1	80.80
8	Upper Probe (natural & propane)	9004238215	0 20363 13503 4	1	85.20

Notes:

---



---



---



---



---

# COMMERCIAL

## High Efficiency

### BURNER/BLOWER ASSEMBLY

#### 60-120 BTH/SUF/HCG

Item No.	Description	Kit #	UPC Code	Qty.	List Price
1	Blower (natural & propane)	9006272005	0 20363 15647 3	1	\$558.20
2	Burner (natural & propane)	9006275005	0 20363 15633 6	1	269.40
3	Flame Sensor (natural & propane)	9006106205	0 20363 15452 3	1	72.00
4	Igniter (natural & propane)	9006101205	0 20363 15446 2	1	120.00

#### 100-150 BTH/SUF/HCG

Item No.	Description	Kit #	UPC Code	Qty.	List Price
1	Blower (natural & propane)	9006273005	0 20363 15631 2	1	\$577.80
2	Burner (natural & propane)	9006277005	0 20363 15635 0	1	269.40
3	Flame Sensor (natural & propane)	9006106205	0 20363 15452 3	1	72.00
4	Igniter (natural & propane)	9006101205	0 20363 15446 2	1	120.00

#### 100-199 BTH/SUF/HCG

Item No.	Description	Kit #	UPC Code	Qty.	List Price
1	Blower (natural & propane)	9006274005	0 20363 15632 9	1	\$1,110.40
2	Burner (natural & propane)	9006279005	0 20363 15637 4	1	269.40
3	Flame Sensor (natural & propane)	9006106205	0 20363 15452 3	1	72.00
4	Igniter (natural & propane)	9006101205	0 20363 15446 2	1	120.00
5	Gas Valve - Venturi Assembly (natural)	9006285005	0 20363 15643 5	1	562.00
5	Gas Valve - Venturi Assembly (propane)	9006286005	0 20363 15644 2	1	562.00

Notes:

---



---



---

# High Efficiency

# COMMERCIAL

# High Efficiency COMMERCIAL

## BURNER/BLOWER ASSEMBLY Continued

### 100-250 BTH/SUF/HCG

Item No.	Description	Kit #	UPC Code	Qty.	List Price
1	Blower (natural & propane)	9006274005	0 20363 15632 9	1	\$1,110.40
2	Burner (natural & propane)	9006279005	0 20363 15637 4	1	269.40
3	Flame Sensor (natural & propane)	9006106205	0 20363 15452 3	1	72.00
4	Igniter (natural & propane)	9006101205	0 20363 15446 2	1	120.00
5	Gas Valve - Venturi Assembly (natural)	9006285005	0 20363 15643 5	1	562.00
5	Gas Valve - Venturi Assembly (propane)	9006286005	0 20363 15644 2	1	562.00

### GAS VALVE ASSEMBLY – 60-120 BTH/SUF/HCG

Item No.	Description	Kit #	UPC Code	Qty.	List Price
1	Gas Valve (natural)	9004535205	0 20363 13749 6	1	\$214.20
1	Gas Valve (propane)	9007182005	0 20363 16592 5	1	159.00
2	Switch – Low Gas Pressure (natural)	9006256015	0 20363 15614 5	1	100.80
2	Switch – Low Gas Pressure (propane)	9006255015	0 20363 15613 8	1	100.80

### GAS VALVE ASSEMBLY – 100-150 BTH/SUF/HCG

Item No.	Description	Kit #	UPC Code	Qty.	List Price
1	Gas Valve (natural)	9006283005	0 20363 15641 1	1	\$243.60
2	Switch – Low Gas Pressure (natural)	9006256015	0 20363 15614 5	1	100.80
2	Switch – Low Gas Pressure (propane)	9006255015	0 20363 15613 8	1	100.80

Notes:

---



---



---



# COMMERCIAL High Efficiency

### ELECTRONIC ANODES

Part Number	Description	List Price
9006246005	Electronic Anode - long	\$389.20
9006247005	Electronic Anode - short	151.40

### CONCENTRIC VENT KITS FOR HIGH EFFICIENCY

Part Number	B&G Part Number	List Price
9006328005	High Efficiency 120-300	\$175.00
9006144005	High Efficiency 400 & UP	661.20

### MANIFOLD KITS

Part Number	Description	List Price
9006680005	Dual Manifold	\$ 668.00
9006681005	Triple Manifold	1,578.00
9006682005	Quad Manifold	1,892.00

Notes:

---



---



---



---



---

# Warranty Kits

RESIDENTIAL

RESIDENTIAL

Warranty Kits

## SELECT® 10 & SELECT® 8 WARRANTY EXTENSION KITS

Place orders with the Service Parts Department at 800-821-2017

State offers three kits enabling licensed plumbing contractors to extend the limited warranty on eligible State SELECT® water heaters—a 2-year kit that extends the warranty to 8 years, and two stages of 4-year kits that extend the warranty to 10 years. The following State Select® models are eligible for the State SELECT® 10 or State SELECT® 8 warranty extension:

STAGE I GAS MODELS				STAGE I ELECTRIC MODELS			
GS6 30 YORT	GS6 30 YBRS	GS6 40 YRRT	GS6 30 YOCT	ES6 30 DORT	ES6 66 DORT	ES6 30 DOLS	ES6 52 DOCT
GS6 40 YBRT	GS6 40 YBRS	GS6 50 YRRT	GS6 40 YOCT	ES6 40 DORT	ES6 30 DORS	ES6 40 DOLNS	ES6 66 DOCT
GS6 50 YBRT	GS6 50 YBRS	GS6 50 YRRT5	GS6 50 YOCT	ES6 52 DORT	ES6 40 DORS	ES6 50 DOLS	ES6 50 DOCS
GS6 30 YORS		GS6 65 YRRT		ES6 55 DORT	ES6 50 DORS	ES6 40 DOCT	

STAGE II GAS MODELS				STAGE II ELECTRIC MODELS		
GS6 40 YBDS	GS6 30 UORT	GS6 40 YRRT	GS6 40 YBPDT	ES6 80 DOCT	ES6 80 DORT	ES6 120 DORT
GS6 50 YBDS	GS6 40 UBRT	GS6 50 YRRT	GS6 50 YBPDT			
GS6 50 YBDS	GS6 50 UBRT	GS6 40 YBVIT2	GS6 50 YRPDT5			
GS6 75 YBRS	GS6 40 UOCT	GS6 50 YRVIT2	GS6 75 YRPDT			
	GS6 50 UOCT	GS6 40 YRVIT				
		GS6 50 YRVIT				
		GS6 50 YRVIT5				
		GS6 75 YRVIT				

This kit contains instructions, an extension sticker, a hot water outlet secondary anode assembly and cold water nipple with the Silencer™ heat traps. Cannot be used with top T&P models ("G" suffix).

Part Number	Description	Approximate Shipping Weight	List Price Each
9004329005	State Select 10 Stage I Warranty Extension Kit	2	\$170.00
9006480005	State Select 10 Stage II Warranty Extension Kit	2	268.00

This kit contains instructions, an extension sticker and a certificate request form.

Part Number	Description	Approximate Shipping Weight	List Price Each
9004328005	State Select 8 Stage I Warranty Extension Kit	2	\$74.00



500 Tennessee Waltz Parkway • Ashland City, Tennessee 37015

For more information:

**Call: 800-821-2017 • Fax: 800-644-9306**